

Product datasheet

Specifications



Easergy P1F 90-250V 3CT 1lo: 0.05-12IN 4DI-4DO RS485 USB

REL15009

EAN Code: 3606481893598

Main

Range of product	PowerLogic
Product or component type	Protection relay
Relay application	Feeder
product reference	P1
Device mounting	Flush
Mounting support	Fixing kit
Mounting mode	Flush-mounted
power supply	90...240 V AC 90...250 V DC
measuring inputs	: 1/5 A CT phase current 4
number of Digital Inputs (DI)	4
number of Digital Outputs (DO)	4 DO 1 watchdog
type of temperature module connection	1 twisted shielded pair
communication ports	1 RS485 on rear 1 USB type mini B on front
communication protocols	CEI 60870-5-103 Modbus RTU
Cybersecurity	Password protection
protection functions	Breaker failure 50BF Phase overcurrent 50/51 Earth fault overcurrent 50N/51N Lockout relay 86 Thermal overload protection 49 Cold load pick-up Switch ON to fault (SOTF)
Arc flash protection	No
measurement functions	Current 3-phase Current RMS Current peak Frequency Temperature overload
control functions	Local/remote control I/O push-button Digital Using serial port
monitoring functions	Trip circuit supervision 74 Relay self-monitoring
logs and records	Event recording Trip context information

Switchgear diagnosis type	Trip circuit supervision ANSI code: TCS
Connections - terminals	Snap-on fixed

Complementary

Maximum power consumption in W	13.5 W AC 4 W DC
Software name	ESetup Easergy Pro: device setup
Display type	Graphic display terminal
Number of key	9
Local signalling	6 x LED red/orange programmable 1 x LED red relay trip indicator 1 x LED green watchdog
Device connection	Serial port 1 shielded twisted pair
Communication compatibility	IEC 60870-5-103 Modbus RTU
Standards	EN 60255-26:2009 EN 60255-1:2010 EN 60255-27:2005
Product certifications	CE
Height	Embedded: 101.5 mm Total: 116.5 mm
Width	Embedded: 101.5 mm Total: 116.5 mm
Depth	Embedded : 108 mm Total : 119 mm
Net weight	0.8 kg maximum

Environment

Directives	2006/95/EC - low voltage directive 2004/108/EC - electromagnetic compatibility
Electromagnetic compatibility	Electromagnetic immunity level 3 conforming to EN 61000-4-2/3/4/5/6/8
Mechanical robustness	Seismic tests: 2 Gn horizontal, 1 Gn vertical conforming to EN 60255-21-3 Shocks (level: class 1) : 5 Gn for 11 ms conforming to EN 60255-21-2 Shocks withstand (level: class 1) : 10 Gn for 16 ms conforming to EN 60255-21-2 Bumps (level: class 1) : 15 Gn for 11 ms conforming to EN 60255-21-2 Vibrations (level: class 1) : 1 Gn, 10...150 Hz, 1 cycle conforming to EN 60255-21-1
Ambient air temperature for operation	-25...60 °C -30...70 °C (16 h)
IP degree of protection	IP54 conforming to IEC 60529
Relative humidity	0...93 % at 40 °C, 21 days 0...93 % at 60 °C, 10 days 93 % at 25...55 °C, 6 cycles, 12 + 12 hours

Packing Units

Unit Type of Package 1	PCE
Number of Units in Package 1	1
Package 1 Height	19.5 cm
Package 1 Width	16.5 cm
Package 1 Length	16.5 cm
Package 1 Weight	917.0 g

Unit Type of Package 2	S03
Number of Units in Package 2	6
Package 2 Height	30.0 cm
Package 2 Width	30.0 cm
Package 2 Length	40.0 cm
Package 2 Weight	5.943 kg

Contractual warranty

Warranty	18 months
-----------------	-----------

Environmental Data

Schneider Electric aims to achieve Net Zero status by 2050 through supply chain partnerships, lower impact materials, and circularity via our ongoing “Use Better, Use Longer, Use Again” campaign to extend product lifetimes and recyclability.

[Environmental Data explained >](#)

[How we assess product sustainability >](#)

Environmental footprint

Carbon footprint (kg.eq.CO2 per CR, Total Life cycle)	229
---	-----

Environmental Disclosure	Product Environmental Profile
--------------------------	---

Use Better

Materials and Substances

Packaging made with recycled cardboard	No
--	----

Packaging without single use plastic	No
--------------------------------------	----

EU RoHS Directive	Compliant with Exemptions
-------------------	---------------------------

REACH Regulation	REACH Declaration
------------------	-----------------------------------

China RoHS Regulation	China RoHS declaration
-----------------------	--

Use Again

Repack and remanufacture

Circularity Profile	End of Life Information
---------------------	---

Take-back	No
-----------	----

Technical Illustration

Wiring diagram

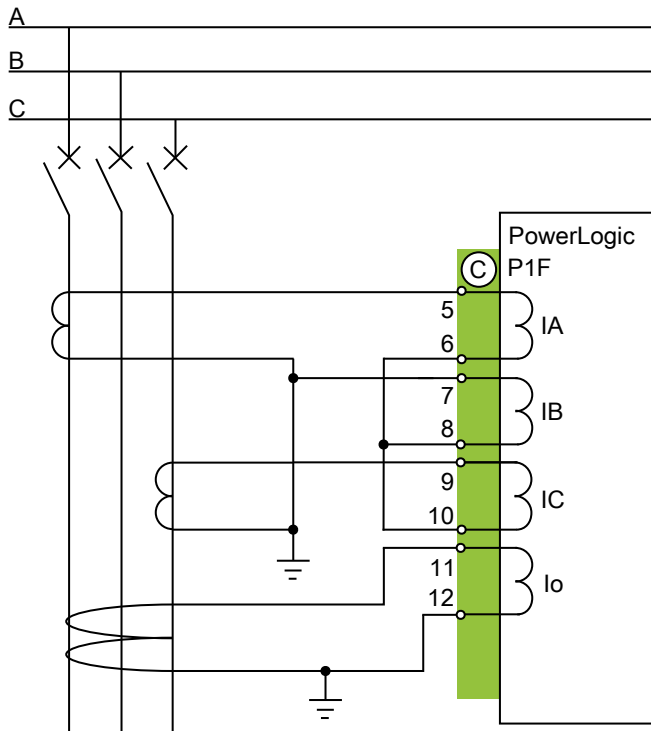

Image of product / Alternate images

Alternative





Technical Illustration

Assembly's dimensions

